



# Neuro/ Spinal Surgery

Forceps	115
Scissors	117
Dissectors and Probes	118
Hooks and Currettes	119
Retractors	120
Elevators	123
Suction Tubes	124
Rongeurs	125

## Adson Dissecting Forceps

Bayonet, 1-2 teeth, jaw 2.5mm at tip



Code	Description
SC-NEU/001c	191mm long

## Jefferson Dressing Forceps



Code	Description
SC-NEU/013	Serrated jaws, 178mm long

## Adson Dissecting Forceps

Bayonet, fine, serrated jaws, jaw 2.5mm at tip

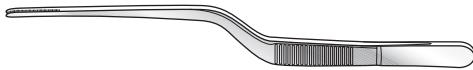

Code	Description
SC-NEU/009	178mm long

## Jefferson Forceps



Code	Description
SC-NEU/002	Fine, 1-2 teeth, 178mm long

## Northfield Dressing Forceps

Extra light, serrated jaws



Code	Description
SC-NEU/014	1mm wide, 203mm long

## Pennybacker Dissecting Forceps



Code	Description
SC-NEU/005	3-4 teeth, 165mm long

# Forceps

## Silcock Iris Forceps

102mm long



Code	Description
SC-NEU/006	1-2 teeth
SC-NEU/015	Serrated jaws

## Dott Dissecting Forceps

Fine, 1-2 teeth



Code	Description
SC-NEU/004	178mm long

## Cairns Dissecting Forceps

Delicate, 2-3 teeth



Code	Description
SC-NEU/003a	165mm long
SC-NEU/003b	216mm long

## Dott Dressing Forceps

Angled

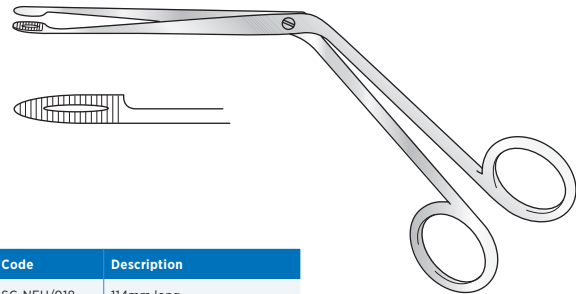

Code	Description
SC-NEU/018	114mm long

## Cairns (Dott) Dressing Forceps

Serrated jaws



Code	Description
SC-NEU/010	Medium, 2mm wide, 216mm long
SC-NEU/012	Fine, 1mm wide, 178mm long

## Tilley Dressing Forceps

Angled, serrated ends

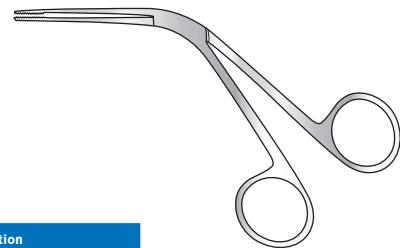

Code	Description
SC-NEU/017	89mm long

## Cairns Scissors

Angled on flat

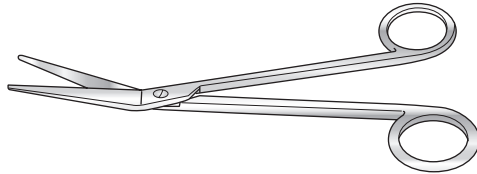

Code	Description
SC-NEU/020	178mm long

## Olivecrona Scissors

Angled, with all micro serrated blade

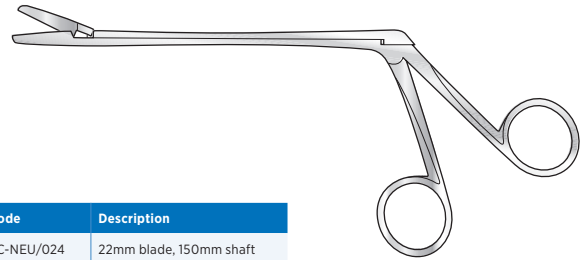

Code	Description
SC-NEU/024	22mm blade, 150mm shaft

## McKissock Scissors

Straight

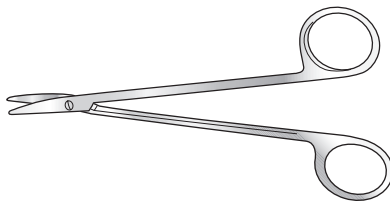

Code	Description
SC-NEU/021a	146mm long

## Schmieden (Taylor) Scissors

Angled, probe-pointed under blade

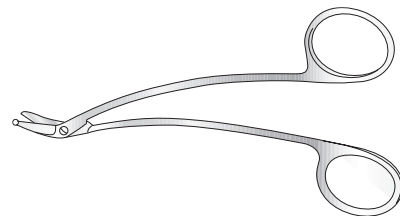

Code	Description
SC-NEU/023	146mm long

## Sweet Scissors

Delicate

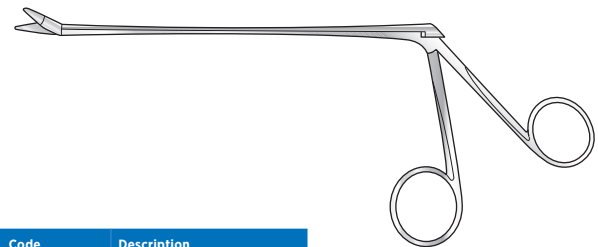

Code	Description
SC-NEU/025a	7mm blade, 144mm shaft
SC-NEU/030	13mm blade, 117mm shaft

## The Original Titanium Rhoton Dissector Set

from Symmetry Surgical



+  
19 dissectors  
in a purpose  
designed  
case

- ✓ Made from lightweight titanium for balance, durability and corrosion resistance
- ✓ Design features include round, deeply knurled handles which facilitate non-slip, finger-controlled micro manipulation

Order your set today  
[info@surgicalholdings.co.uk](mailto:info@surgicalholdings.co.uk)

# Dissectors and Probes

## Cairns Guide and Director

Malleable



Code	Description
SC-NEU/080	127mm long

## Pennybacker Probe Dissector

Double ended



Code	Description
SC-NEU/101	229mm long

## Dissector

200mm long



Code	Description
SC-NEU/N30210	Soft
SC-NEU/N30220	Soft, with hole

## Swedish Dissector

Double ended



Code	Description
SC-NEU/100a	Light model, 178mm long
SC-NEU/100b	Heavy model, 200mm long

## Penfield Dissector



### No 1

Broad curve, with 7.5mm sharp round spoon, 184mm long



### No 2

7.5mm sharp round spoon with wax packer, 178mm long



### No 3

Full curve and wax packer, 197mm long



### No 4

Slight curve, 4mm wide, 216mm long

Code	Description
SC-NEU/069a	No 1
SC-NEU/069b	No 2
SC-NEU/069c	No 3
SC-NEU/069d	No 4

## Watson Cheyne Dissector

Fine, double-ended, with probe end



Code	Description
SC-GI/287	127mm long
SC-GI/288	191mm long
SC-GI/288a	230mm long
SC-GI/288b	255mm long

# Hooks and Curettes

## Hooks

### Adson Hook

178mm long



Code	Description
SC-NEU/078a	Angled
SC-NEU/078b	Straight
SC-NEU/078b-b	Straight, blunt

### Adson Oliver Neuro Hook

191mm long

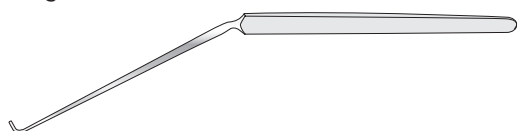

Code	Description
SC-NEU/082a	Angled downward, blunt
SC-NEU/082b	Sharp
SC-NEU/082c	Angled upward, blunt

### Cairns Tissue Hook

127mm long



Code	Description
SC-NEU/081b	Half round, sharp
SC-NEU/081c	Angled, sharp

### Oliver Tissue Hook

Blunt



Code	Description
SC-NEU/081a	127mm long

## Curettes

### Falconer Scoop Curette

Double ended, angled ends



Code	Description
SC-NEU/099	191mm long

### American Spinal Fusion Curettes

Blue acetal handles, 254mm long



#### Straight

Code	Description
SC-NEU/074a	Size 000 2mm x 4mm
SC-NEU/074b	Size 00 2.5mm x 4.5mm
SC-NEU/074c	Size 0 2.75mm x 5mm
SC-NEU/074d	Size 1 3mm x 5.5mm
SC-NEU/074e	Size 2 3.25mm x 6mm
SC-NEU/074f	Size 3 4mm x 7mm
SC-NEU/074g	Size 4 6mm x 9.5mm
SC-NEU/074h	Size 5 7mm x 14mm
SC-NEU/074i	Size 6 9mm x 17mm

#### Angled

Code	Description
SC-NEU/074j	Size 000 2mm x 4mm
SC-NEU/074k	Size 00 2.5mm x 4.5mm
SC-NEU/074l	Size 0 2.75mm x 5mm
SC-NEU/074m	Size 1 3mm x 5.5mm
SC-NEU/074n	Size 2 3.25mm x 6mm
SC-NEU/074o	Size 3 4mm x 7mm
SC-NEU/074p	Size 4 6mm x 9.5mm
SC-NEU/074q	Size 5 7mm x 14mm
SC-NEU/074r	Size 6 9mm x 17mm

ALSO AVAILABLE WITH ACETAL SUREGRIP HANDLE  
ADD SUFFIX BH TO CATALOGUE NUMBER

# Retractors

## Mastoid Retractor

3 x 3 blunt hooks

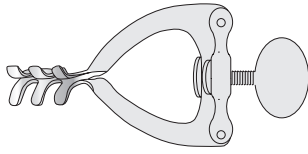

Code	Description
SC-NEU/N30350	114mm long

## Henderson Retractor

Self retaining, straight, 4 x 4 blunt pointed blades

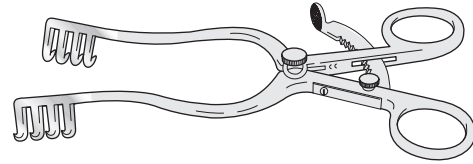

Code	Description
SC-NEU/030a	178mm long

## Jansen (Shea) Retractor

Self retaining, blunt blades

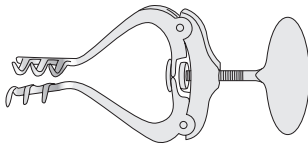

Code	Description
SC-NEU/028	114mm long

## Cairns Scalp Retractor

Curved, self retaining, swivel blades

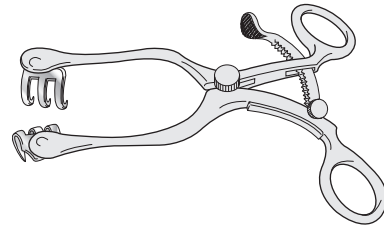

Code	Description
SC-NEU/025b	140mm long

## Cone Retractor

Self retaining, hinged arms, for use in ventriculography

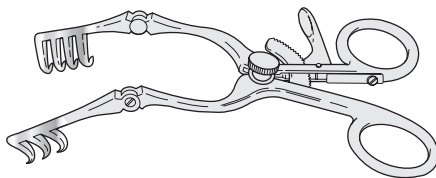

Code	Description
SC-NEU/027	165mm long

## Schnitker Scalp Retractor

Curved, self retaining, blunt swivel blades

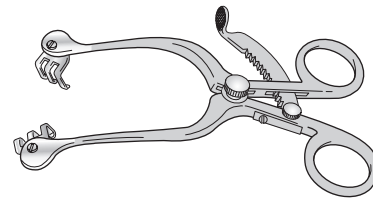

Code	Description
SC-NEU/026	140mm long

## Jefferson Retractor

Self retaining, curved, blunt pointed blades

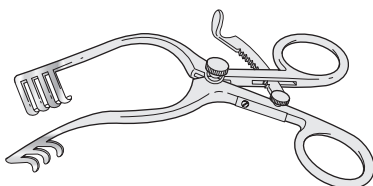

Code	Description
SC-NEU/029	140mm long

## Cone Laminectomy Retractor

Hinged arms, with cam rack

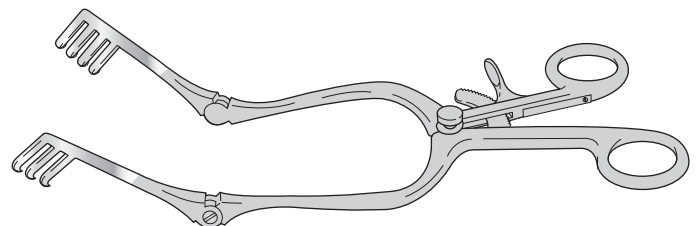

Code	Description
SC-NEU/051	254mm long

## Cone Laminectomy Retractor

Hinged arms

Code	Description
SC-NEU/052a	Left, 165mm long
SC-NEU/052b	Right, 165mm long
SC-NEU/052c	Left, 254mm long
SC-NEU/052d	Right, 254mm long

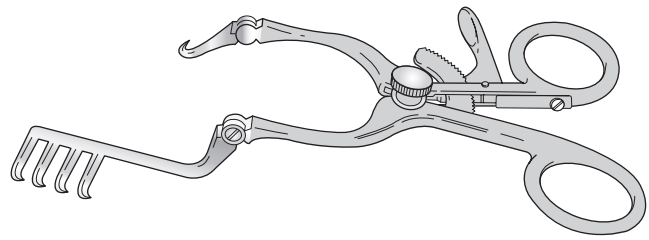

## Harvey-Jackson Laminectomy Retractor

Hinged arms, blades 38mm wide x 44mm deep

Code	Description
SC-NEU/053	305mm long

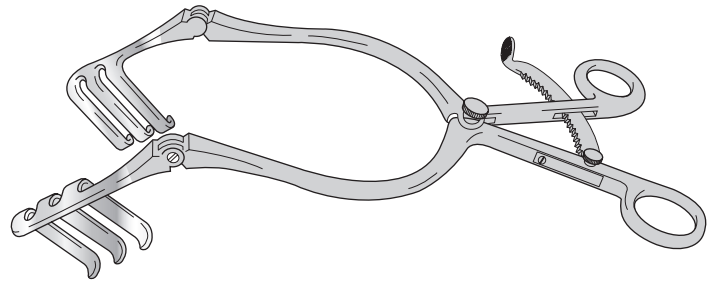

## Mayo-Adson (Beckmann) Laminectomy Retractor

Hinged arms

Code	Description
SC-NEU/054	292mm long

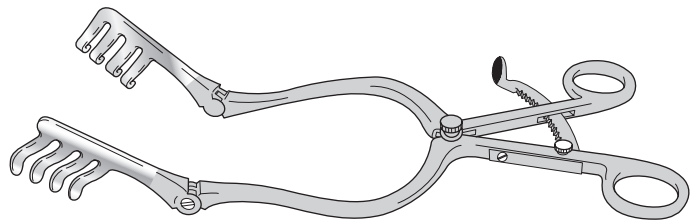

## Northfield (Cairns) Retractor

Hinged arms, one pair of blades

4 prong : 25mm wide x 16mm deep  
and one pair of blades

5 prong: 32mm wide x 25mm deep

Code	Description
SC-NEU/055	292mm long

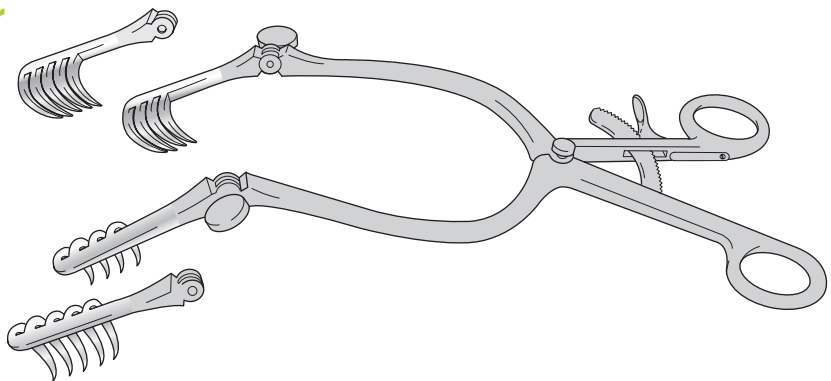

## Meyerding Hemi-Laminectomy Retractor

Code	Description
SC-NEU/216	18cm long 7" blade size 50 x 10mm
SC-NEU/219	18cm long 7" blade size 50 x 20mm
SC-NEU/217	18cm long 7" blade size 60 x 10mm
SC-NEU/220	18cm long 7" blade size 60 x 20mm
SC-NEU/218	18cm long 7" blade size 70 x 10mm
SC-NEU/221	18cm long 7" blade size 70 x 20mm
SC-NEU/224	18cm long blade left 90 x 10mm
SC-NEU/225	18cm long blades left 90 x 20mm
SC-NEU/222	18cm long blades right 90 x 10mm
SC-NEU/223	18cm long blades right 90 x 20mm

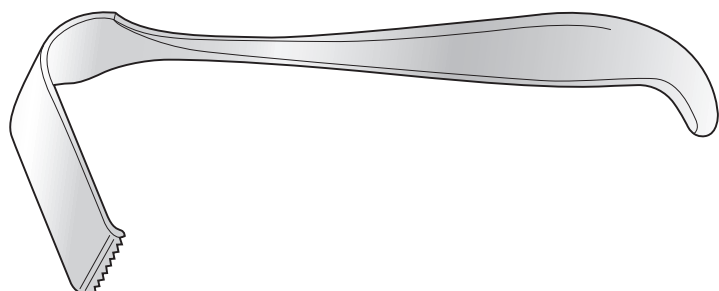



# Retractors

## Cairns-Northfield Laminectomy Retractor

203mm arm length with three pairs of interchangeable swivelling blades, 76mm, 64mm, and 51mm

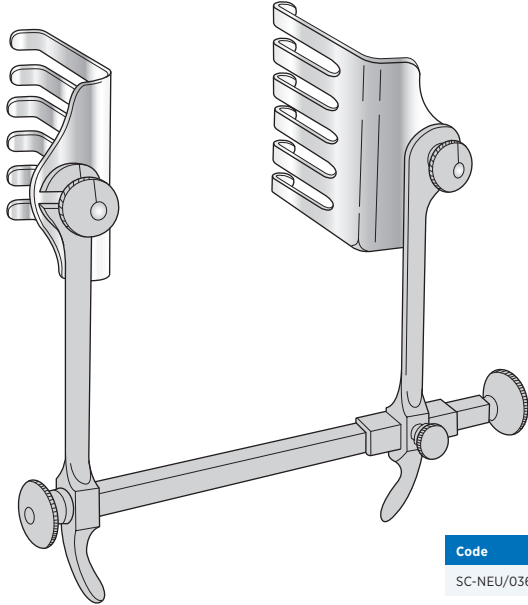

**Code**  
SC-NEU/036

## Hibbs Retractor

203mm long

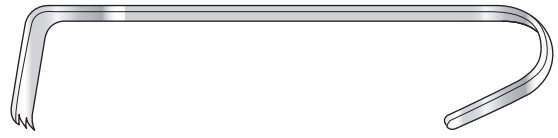

Code	Description
SC-NEU/050a	Blades 10mm x 38mm
SC-NEU/050b	Blades 16mm x 54mm

## Krayenbuhl Retractor

6mm wide

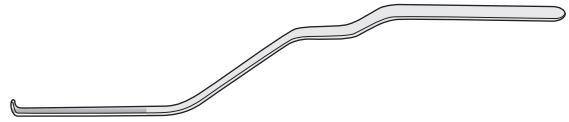

Code	Description
SC-NEU/5905	210mm long
SC-NEU/5905a	240mm long

## Cairns 'Rake' Scalp Retractor

Sharp, 210mm long

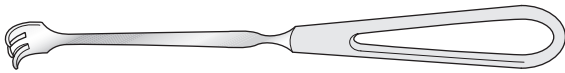

Code	Description
SC-NEU/032a	3 prong, 16mm wide
SC-NEU/032b	4 prong, 19mm wide

## Love Retractor

6mm wide

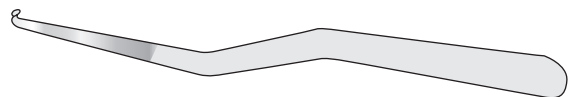

Code	Description
SC-NEU/5905b	210mm long

## Cairns (Cushing) Scalp Retractor

Solid blade

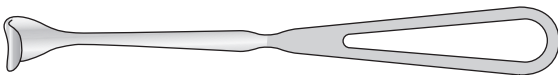

Code	Description
SC-NEU/033	16mm wide, 210mm long

## Love Retractor

203mm long



Code	Description
SC-NEU/077a	Straight, blade 5mm x 5mm
SC-NEU/077b	Shaft angled 90° at handle
SC-NEU/077c	Shaft angled 45° at handle

## Cairns Strip Retractor

Malleable, 203mm long  
8 sizes: 6, 8, 10, 11, 13, 16, 19, 25mm

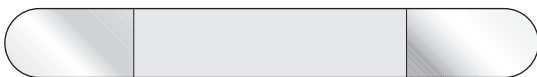

Code	Description
SC-NEU/034a	20 SWG
SC-NEU/034b	18 SWG

## O'Connell Retractor

Double ended



Code	Description
SC-NEU/076	216mm long

## Cobb Spinal Elevator

13mm wide, knurled handle

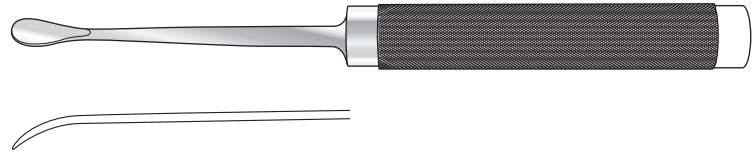

## Cobb Spinal Elevator

With blue acetal handles, 279mm long

Code	Description
SC-NEU/073a	10mm wide
SC-NEU/073b	13mm wide
SC-NEU/073c	19mm wide



ALSO AVAILABLE WITH ACETAL SUREGRIP HANDLE  
ADD SUFFIX BH TO CATALOGUE NUMBER

## Adson Periosteal Elevator

Serrated grip, 165mm long

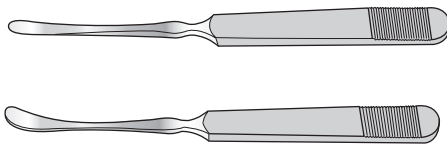

straight

Code	Description
SC-OR/N028	7mm wide

curved

Code	Description
SC-OR/N029	5mm wide
SC-OR/N030	7mm wide

## McKissock Spade Periosteal Elevator

Straight



Code	Description
SC-NEU/072	197mm long

## Cushing Periosteal Elevator

Slightly curved end



Code	Description
SC-NEU/071	197mm long

## Pennybacker Elevator

Curved, sharp, 171mm long

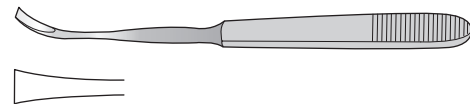

Code	Description
SC-OR/N025	6mm wide

# Suction Tubes

## Adson Frazier Suction Tube

Angled, fully insulated, 180mm long



Code	Description
SC-NEU/094c	8 F.G.

## Retractor Suction Tube

With stilette, 220mm long

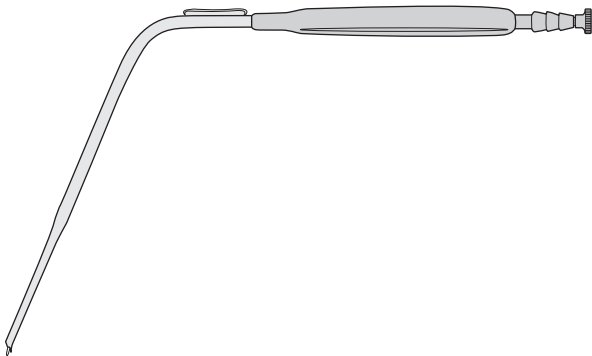

Code	Description
SC-NEU/SK001STIL	Replacement stilette

## Frazier Suction Tubes

Malleable, silver, angled, 180mm long

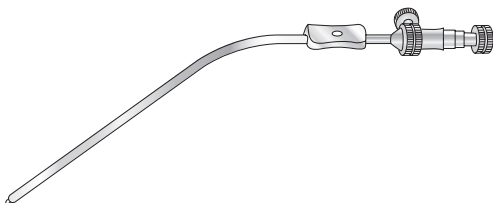

Code	Description
SC-NEU/092a	7 F.G.
SC-NEU/092b	8 F.G.
SC-NEU/092c	9 F.G.

## Dandy Rongeur

Straight

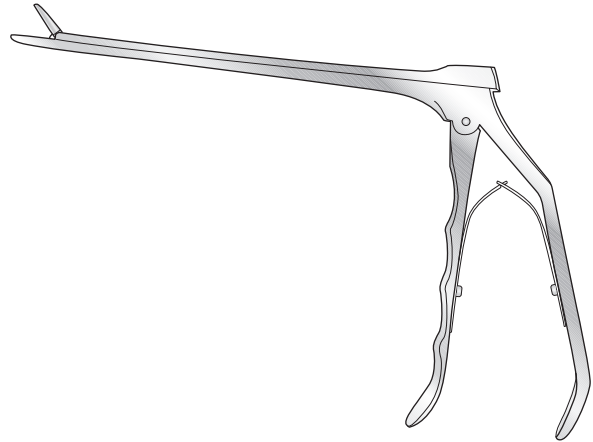

Code	Description
SC-NEU/134	3mm bite, 178mm shaft

## Falconer Rongeur

Oblique jaws

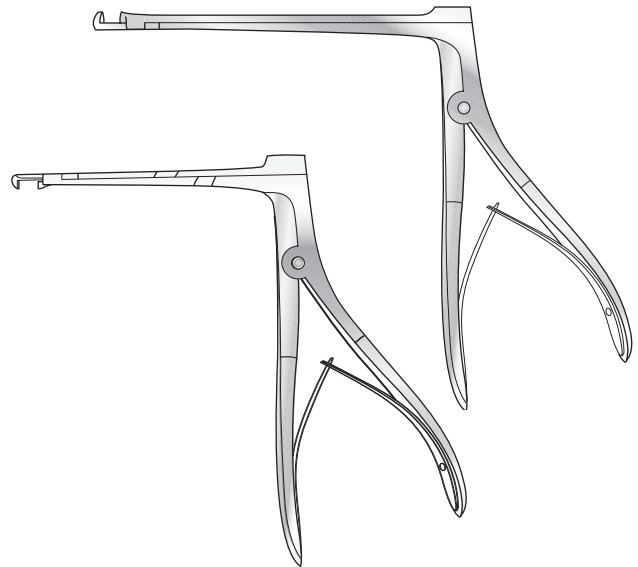

Code	Description
SC-NEU/122a	Upward cutting, 3mm bite, 110mm shaft
SC-NEU/122b	Upward cutting, 5mm bite, 110mm shaft
SC-NEU/122c	Downward cutting, 3mm bite, 85mm shaft
SC-NEU/122d	Downward cutting, 5mm bite, 110mm shaft

## Beck Rongeur

Straight, for intervertebral disc

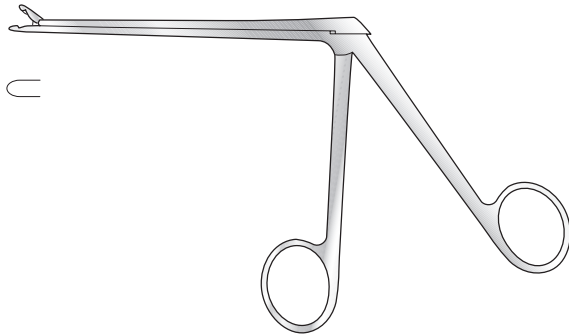

Code	Description
SC-NEU/125	2mm bite, 130mm shaft

## Love-Grunwald Rongeur

Cup shaped, jaws 3mm x 10mm, 178mm shaft

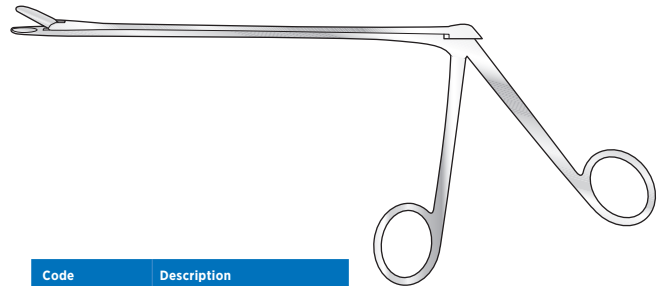

Code	Description
SC-NEU/131a	Straight
SC-NEU/131b	Curved upward
SC-NEU/131c	Curved downward

## Cushing Rongeur

130mm shaft

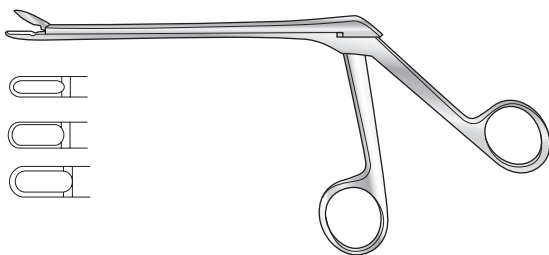

Code	Description
SC-NEU/127-2	2mm bite
SC-NEU/127-3	3mm bite
SC-NEU/127-4	4mm bite
SC-NEU/127-5	5mm bite
SC-NEU/127-6	6mm bite

## Mackay Rongeur

140°, straight, 114mm shaft

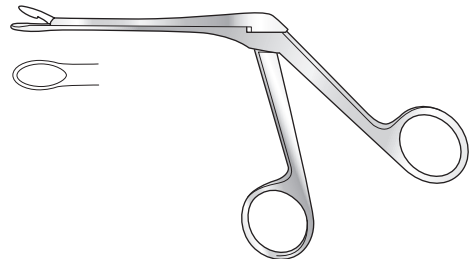

Code	Description
SC-SH/4249	5.5mm

## Cushing Rongeur

130mm shaft

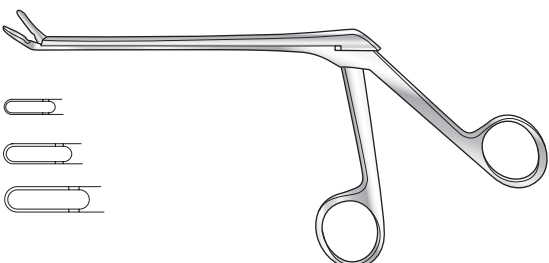

150° upward cutting

Code	Description
SC-NEU/128c	2mm bite
SC-NEU/128	3mm bite
SC-NEU/128a	4mm bite
SC-NEU/128b	5mm bite

150° downward cutting

Code	Description
SC-NEU/130c	2mm bite
SC-NEU/130	3mm bite
SC-NEU/130a	4mm bite
SC-NEU/130b	5mm bite

## Northfield Rongeur

Curved, upward cutting

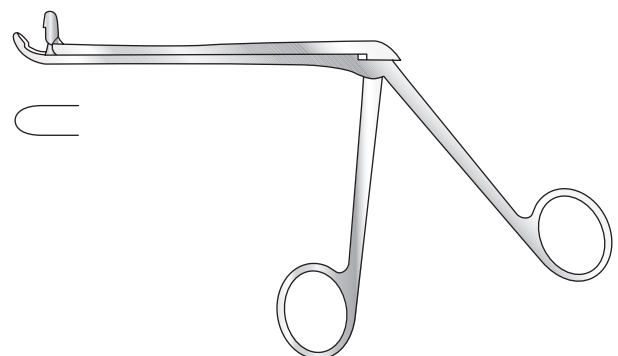

Code	Description
SC-NEU/132	4mm bite, 133mm shaft

# Rongeurs

## Pennybacker Rongeur

120mm shaft

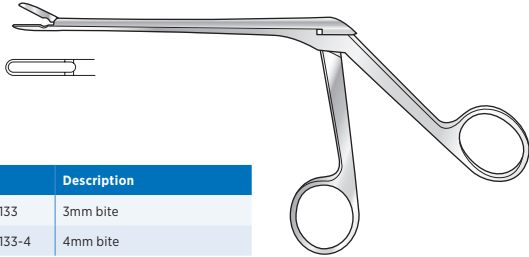

Code	Description
SC-NEU/133	3mm bite
SC-NEU/133-4	4mm bite

## Daniel Rongeur

Miniature, for neuropathology

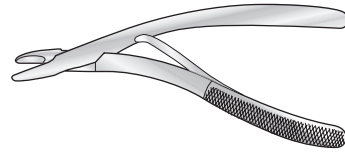

Code	Description
SC-NEU/104	1.5mm bite, 127mm long

## St Bart's Rongeur

114mm shaft



Code	Description
SC-ENT/140a	3mm bite

## Cairns Rongeur

Fine jaws, angled on flat, serrated jaws, curved handles

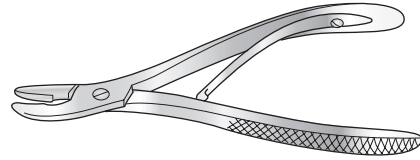

Code	Description
SC-NEU/103	4mm bite 152mm long

## St Bart's Rongeur

140°, downward cutting, 114mm shaft

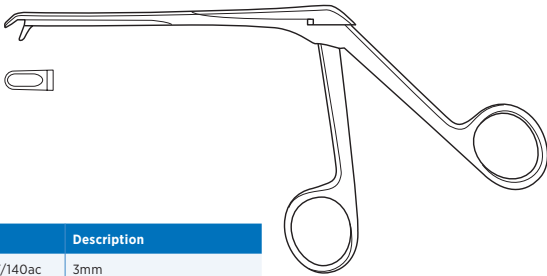

Code	Description
SC-ENT/140ac	3mm

## Danish Pattern Rongeur

Angled on flat, fine jaws, curved handles, screw joint

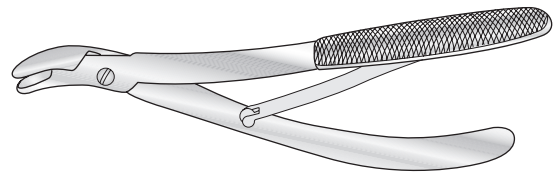

Code	Description
SC-NEU/109	4mm bite, 203mm long

## St Bart's Rongeur

140°, upward cutting, 114mm shaft

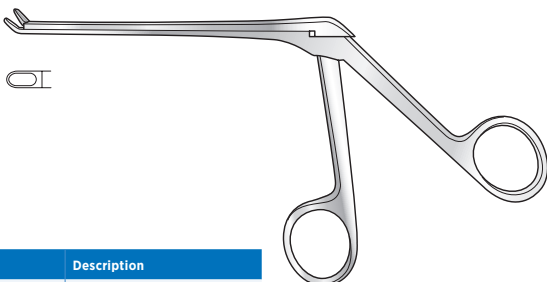

Code	Description
SC-ENT/140b	3mm

## Falconer Rongeur

Angled to side, light, screw joint

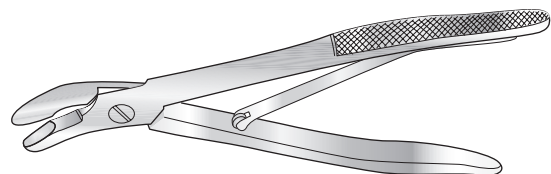

Code	Description
SC-NEU/110	6mm bite, 203mm long

## Wilms Rongeur

Angled on flat, narrow jaws

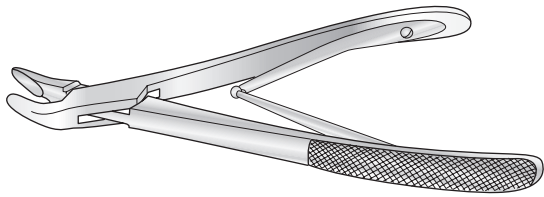

Code	Description
SC-NEU/114	4mm bite, 203mm long

## Pennybacker Rongeur

Straight, fine jaws, 203mm long

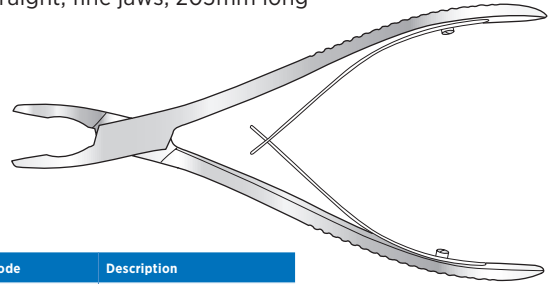

Code	Description
SC-NEU/107	4mm bite

## Glasgow Pattern Rongeur

Slightly curved on flat, screw joint

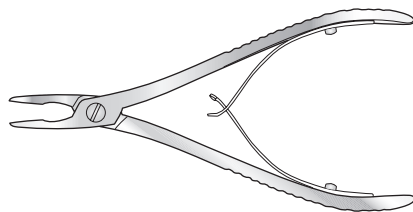

Code	Description
SC-NEU/111	4mm bite, 146mm long

## Northfield Rongeur

Straight, 10mm bite

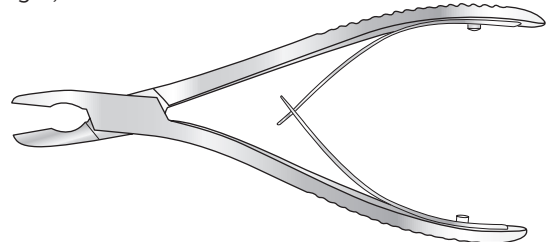

Code	Description
SC-NEU/106	One shallow blade, 200mm long

## Heanley Rongeur

Long fine straight jaws, screw joint

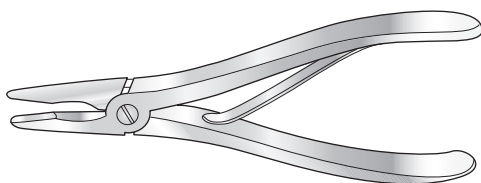

Code	Description
SC-NEU/112	4mm bite, 178mm long

## Stokey Rongeur

Angled to side, fine jaws

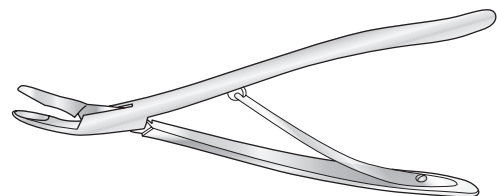

Code	Description
SC-NEU/108	3mm bite, 178mm long

## Jansen Rongeur

Short curve, screw joint

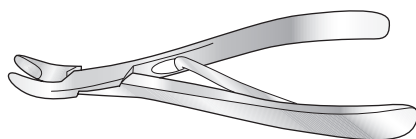

Code	Description
SC-NEU/105	8mm bite, 152mm long

## Trotter Rongeur

Angled to side, strong, screw joint

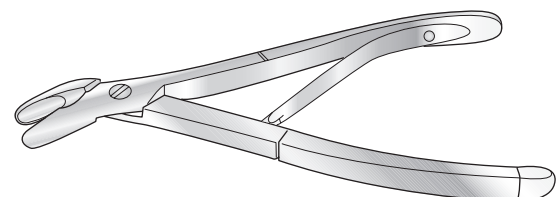

Code	Description
SC-NEU/113	10mm bite, 203mm long

# Rongeurs

## Luer-Jansen Rongeur

Light, curved on flat, compound action

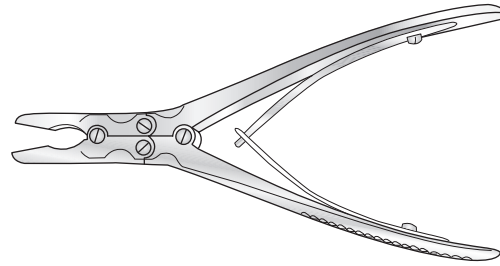
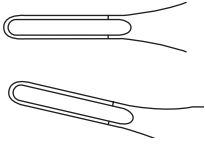

Code	Description
SC-NEU/116	4mm bite, 197mm long

## Olivecrona Rongeur

Angled to side, compound action, 229mm long

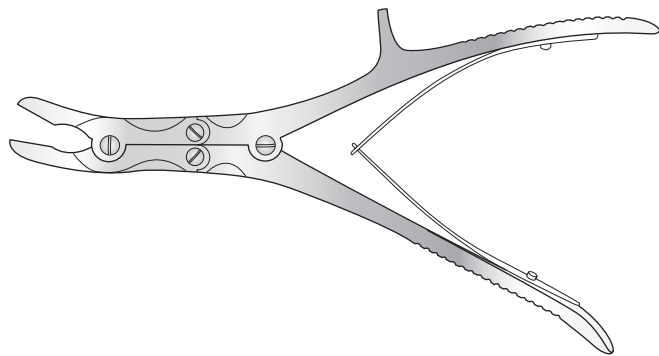

Code	Description
SC-NEU/119a	5mm bite
SC-NEU/119b	6mm bite

## Ruskin Rongeur

Curved on flat, compound action

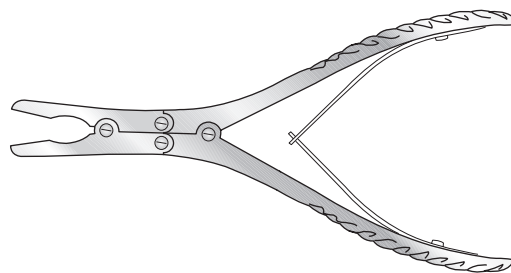

Code	Description
SC-NEU/118	6mm bite, 184mm long

## Leksell Rongeur

Curved to side, compound action

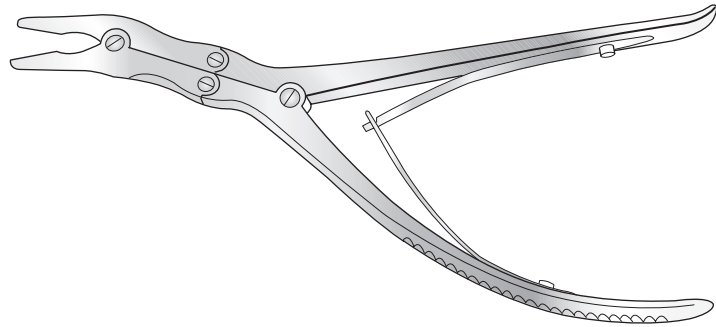
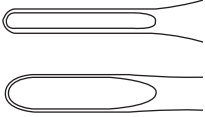

Code	Description
SC-NEU/115a	Small, 6mm bite, 229mm long
SC-NEU/115b	Large, 8mm bite, 254mm long

## Luer Stille Bone Rongeur

Curved, 250mm long

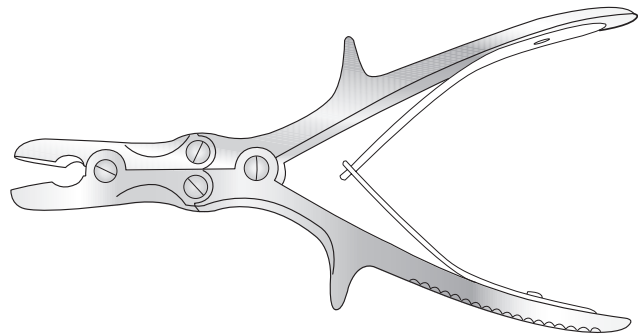
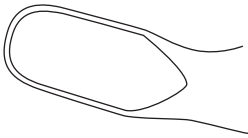

Code	Description
SC-OR/071b	11mm bite
SC-NEU/117	Heavy, 229mm long

## Swedish Pattern Laminectomy Shears

Double crank, compound action

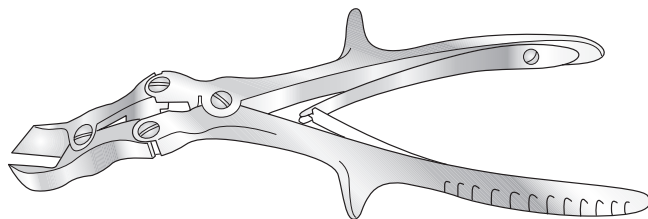

Code	Description
SC-NEU/121	267mm long



# Rongeurs

## Kerrison Rongeurs

Cloward disc punch (not illustrated)  
130° upward cutting, 190mm long

BLACK CERAMIC COATED KERRISSONS AVAILABLE  
PLEASE ADD SUFFIX -BK WHEN ORDERING

Code	Description
SC-NEU/CL002	2mm wide
SC-NEU/CL003	3mm wide
SC-NEU/CL004	4mm wide
SC-NEU/CL005	5mm wide
SC-NEU/CL006	6mm wide



Kerrison punch

1mm 2mm 3mm 4mm 5mm

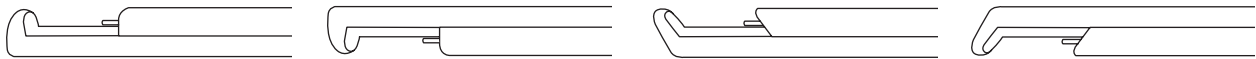

## Non-Detachable

### 90° upward cutting

Code	Description
SC-NEU/136	180mm(L) x 1mm(W)
SC-NEU/137	180mm(L) x 2mm(W)
SC-NEU/138	180mm(L) x 3mm(W)
SC-NEU/139	180mm(L) x 4mm(W)
SC-NEU/140	180mm(L) x 5mm(W)
SC-NEU/141	230mm(L) x 2mm(W)
SC-NEU/142	230mm(L) x 3mm(W)
SC-NEU/143	230mm(L) x 4mm(W)
SC-NEU/144	230mm(L) x 5mm(W)

### 90° downward cutting

Code	Description
SC-NEU/154	180mm(L) x 1mm(W)
SC-NEU/155	180mm(L) x 2mm(W)
SC-NEU/156	180mm(L) x 3mm(W)
SC-NEU/157	180mm(L) x 4mm(W)
SC-NEU/158	180mm(L) x 5mm(W)
SC-NEU/159	230mm(L) x 2mm(W)
SC-NEU/160	230mm(L) x 3mm(W)
SC-NEU/161	230mm(L) x 4mm(W)
SC-NEU/162	230mm(L) x 5mm(W)

### 130° upward cutting

Code	Description
SC-NEU/172	180mm(L) x 1mm(W)
SC-NEU/173	180mm(L) x 2mm(W)
SC-NEU/174	180mm(L) x 3mm(W)
SC-NEU/175	180mm(L) x 4mm(W)
SC-NEU/176	180mm(L) x 5mm(W)
SC-NEU/177	200mm(L) x 3mm(W)
SC-NEU/178	200mm(L) x 4mm(W)
SC-NEU/179	200mm(L) x 5mm(W)
SC-NEU/180	200mm(L) x 6mm(W)
SC-NEU/181	230mm(L) x 2mm(W)
SC-NEU/182	230mm(L) x 3mm(W)
SC-NEU/183	230mm(L) x 4mm(W)
SC-NEU/184	230mm(L) x 5mm(W)

### 130° downward cutting

Code	Description
SC-NEU/198	180mm(L) x 1mm(W)
SC-NEU/199	180mm(L) x 2mm(W)
SC-NEU/200	180mm(L) x 3mm(W)
SC-NEU/201	180mm(L) x 4mm(W)
SC-NEU/202	180mm(L) x 5mm(W)
SC-NEU/203	230mm(L) x 2mm(W)
SC-NEU/204	230mm(L) x 3mm(W)
SC-NEU/205	230mm(L) x 4mm(W)
SC-NEU/206	230mm(L) x 5mm(W)

## Detachable

### 90° upward cutting

Code	Description
SC-NEU/145	180(L) x 1mm(W)
SC-NEU/146	180(L) x 2mm(W)
SC-NEU/147	180(L) x 3mm(W)
SC-NEU/148	180(L) x 4mm(W)
SC-NEU/149	180(L) x 5mm(W)
SC-NEU/150	230(L) x 2mm(W)
SC-NEU/151	230(L) x 3mm(W)
SC-NEU/152	230(L) x 4mm(W)
SC-NEU/153	230(L) x 5mm(W)

### 90° downward cutting

Code	Description
SC-NEU/163	180(L) x 1mm(W)
SC-NEU/164	180(L) x 2mm(W)
SC-NEU/165	180(L) x 3mm(W)
SC-NEU/166	180(L) x 4mm(W)
SC-NEU/167	180(L) x 5mm(W)
SC-NEU/168	230(L) x 2mm(W)
SC-NEU/169	230(L) x 3mm(W)
SC-NEU/170	230(L) x 4mm(W)
SC-NEU/171	230(L) x 5mm(W)

### 130° upward cutting

Code	Description
SC-NEU/185	180(L) x 1mm(W)
SC-NEU/186	180(L) x 2mm(W)
SC-NEU/187	180(L) x 3mm(W)
SC-NEU/188	180(L) x 4mm(W)
SC-NEU/189	180(L) x 5mm(W)
SC-NEU/190	200(L) x 3mm(W)
SC-NEU/191	200(L) x 4mm(W)
SC-NEU/192	200(L) x 5mm(W)
SC-NEU/193	200(L) x 6mm(W)
SC-NEU/194	230(L) x 2mm(W)
SC-NEU/195	230(L) x 3mm(W)
SC-NEU/196	230(L) x 4mm(W)
SC-NEU/197	230(L) x 5mm(W)

### 130° downward cutting

Code	Description
SC-NEU/207	180(L) x 1mm(W)
SC-NEU/208	180(L) x 2mm(W)
SC-NEU/209	180(L) x 3mm(W)
SC-NEU/210	180(L) x 4mm(W)
SC-NEU/211	180(L) x 5mm(W)
SC-NEU/212	230(L) x 2mm(W)
SC-NEU/213	230(L) x 3mm(W)
SC-NEU/214	230(L) x 4mm(W)
SC-NEU/215	230(L) x 5mm(W)

## Symmetry Sharp Kerrison®

**Your biggest Kerrison challenges solved with one product:**

- Productive bite every time
- Never have to use a dull Kerrison again
- Minimise the risk of dural tears
- Reduce hand and arm fatigue
- Easily opened for cleaning
- No need to open multiple trays

Contact us for more details [info@surgicalholdings.co.uk](mailto:info@surgicalholdings.co.uk)